

Medsys Medical Systems



**From Robotics
to Surgical
Instruments**

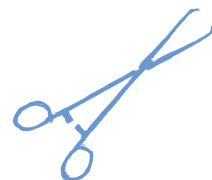
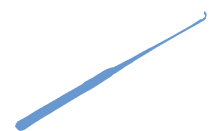
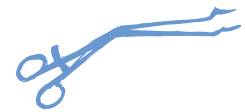

Table of Contents

A. LAPAROSCOPIC PRODUCTS

LAPMAN®	1-2
LAP LOOP	3-4
UTERINE MANIPULATOR.....	5

B. SPECIALITY PRODUCTS

NEXT 200 Monopolar/Bipolar Electrosurgical Generator	6
Non-Conductive Instruments.....	7
Universal Electrosurgical Accessories.....	8
Universal Reusable and Disposable Electrodes.....	8-9
Bipolar Forceps	9
Cervix dilators.....	10
Endometrial Samplers and Dilators.....	11
Cervix needle	11
Special Parametrium Scissors.....	26
Special Hysterectomy Clamps.....	32

C. COLPOSCOPY INSTRUMENTS

Biopsy Forceps	12-15
Endocervical and Endometrial Curettes	16
Tenacula.....	18
Cervical Hooks	18
Endocervical Specula	19
Vaginal Specula.....	19-20

D. GYNECOLOGICAL SURGICAL INSTRUMENTS

Sounds	17
Curettes	17
Uterine Cannula.....	17
Keyes Vulvar Punches	18
Lateral Vaginal Retractors	19-20
Vulsellum Forceps	21
Sponge Forceps.....	21
Scissors	22-26
Dissecting Forceps.....	27
Hemostatic Forceps.....	28-31
Hysterectomy Forceps	31-32
Retractors	33-34
Needle Holders	35-36
Monopolar Scissors.....	37
Monopolar Forceps	37

High Quality is Cost Effective !

Dear Customer,

Since years, MEDSYS has been developing and manufacturing products in the field of women's healthcare for its growing base of customers and distributors throughout the world.

With experienced staff in high quality surgical instruments, the company aims to continue the century old tradition of cutlery and surgical instrument manufacturing - combining high quality and innovation - of the town of Gembloux, Belgium.

We are pleased to introduce our new enlarged product catalog : it focuses on electro-surgery, general surgery instruments and introduces a few very innovative laparoscopic devices developed with European opinion leaders.

It is our belief that our quality is cost effective : our reusable products will last because they are made of selected raw material, manufactured by experienced colleagues using appropriate equipment and according to international standards. MEDSYS provides a 1 year warranty on material and workmanship for all its reusable instruments and equipments, provided that the customer uses the products appropriately and applies "good maintenance practices" applicable to quality products.

MEDSYS' maintenance department provides further service for the repair of our surgical instruments and equipments. Don't hesitate to contact us for any question or troubleshooting related to the products.

As you read through this catalog, if you don't see what you need, please don't hesitate to contact our customer service department and ask for it. There is a good chance that our colleagues can accommodate your demand.

We thank you for your continued confidence and look forward serving you into the future.

Sincerely,



Yves Delpire
Managing Director



LapMan® Dynamic Laparoscope Driver



Get a stable image

Control your vision yourself

Make better use of your staff

“Control your vision yourself”

Introducing the LapMan® into the OR will :

Give back the surgeon the control of his vision

Improve image stability

Produce less eye fatigue

Free the Assistant for more rewarding tasks

Allow Solo Surgery

Features :

Rolling Base makes positioning easy, on either side of the operating table

Connection to laparoscope is easy, fast and scope independent

Set up takes less than 5 minutes

LapStick® :

Fits to any laparoscopic instrument (tailor-made clips)

Surgeon's index controls all scope movements

Sterile Disposable Device

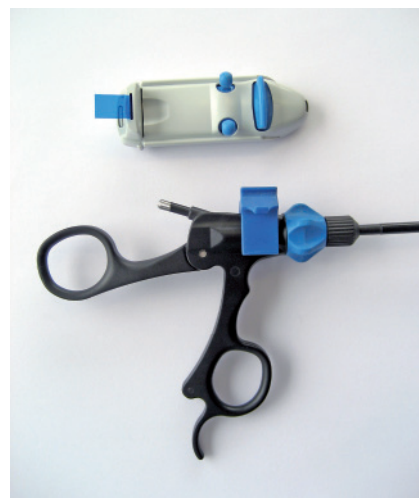

Technical specifications

LapMan®

Weight : 50 Kgs

Dimensions :

Height : 1,2 - 1,5 m

Length : 0,7 m

Width : 0,36 m

LapStick®

Weight : 35 gr

Dimensions :

8,5 cm x 3 cm x 2 cm

“Control your vision yourself”

V 3.0 06/2007

Med
SYS

Dequesne Lap Loop System

For laparoscopic total and subtotal hysterectomy

Safer : specifically designed system avoids possible damage by contact with surrounding tissues during sectioning.

Easier : once the Lap Loop is in place, the sectioning is performed in one single movement.

Faster : one movement replaces time consuming multiple incisions.

Video and publication⁽¹⁾ of Prof. J. DEQUESNE using Lap Loop System available on request

⁽¹⁾Dequesne J, Schmidt N, Foidart JM, Gaspart U, new applications for the Lap Loop in Laparoscopic Surgery. Ref Gynecol Obstet 8 : 537-42

The Lap Loop System comprises a reusable instrument and a disposable Loop.

Introducer



Sheath



Electrode



Patent pending

Procedure for use of Lap Loop System

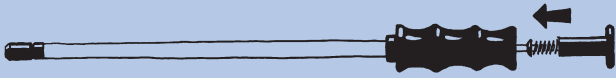

1. Insert the introducer in the sheath.

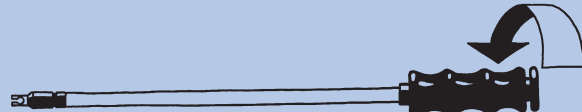

2. Push the introducer so that the distal tip extends out of the sheath and rotate the introducer to lock it in the sheath. (spring compressed)



3. Screw the screw thread end of the Lap Loop electrode into the female thread at the distal tip of the introducer.

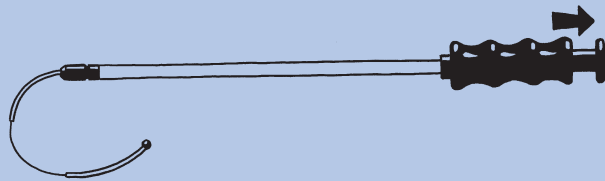

4. Unlock the introducer and pull back the introducer until the entire Loop is withdrawn inside the sheath.

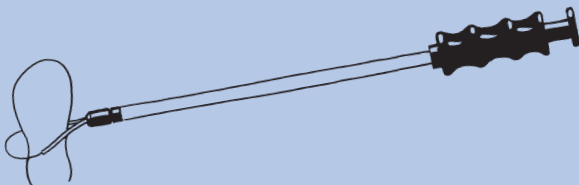

5. Insert the entire Lap Loop System through the trocar.

. Push the introducer so that the Loop is in the operating field. Compress spring, rotate and lock the introducer.

Position the Loop around the uterus.

Locate the ball end of the Loop electrode in the socket at the distal tip of the introducer, using forceps.

6. Rotate the introducer (spring decompressed) so that the Loop ends are completely withdrawn into the sheath.

Connect the monopolar cable adaptor and apply electrical current.

While maintaining the distal end of the sheath close to the uterus, pull back the introducer until uterus is sectioned, stop applying current and remove the monopolar cable adaptor.

Pull back the introducer until the entire Loop is in the sheath and remove sheath out of the trocar.

Remove the introducer out of the sheath, unscrew the Loop and discard it.

Order number :
 110-030 Lap Loop instrument
 120-060D Lap Loop Electrode (box of 5)



UTERINE MANIPULATOR

For laparoscopic hysterectomy

Anatomical :

design of the instrument allows LH in vast majority of cases

Easy :

- no complicated assembly or set-up prior to use
- cleaning and sterilisation as with standard instruments

Quick :

learning curve for placing the uterine manipulator and use of the instrument is short

Cost effective :

the device is fully reusable

Ergonomic handle for easy manipulation by the assistant

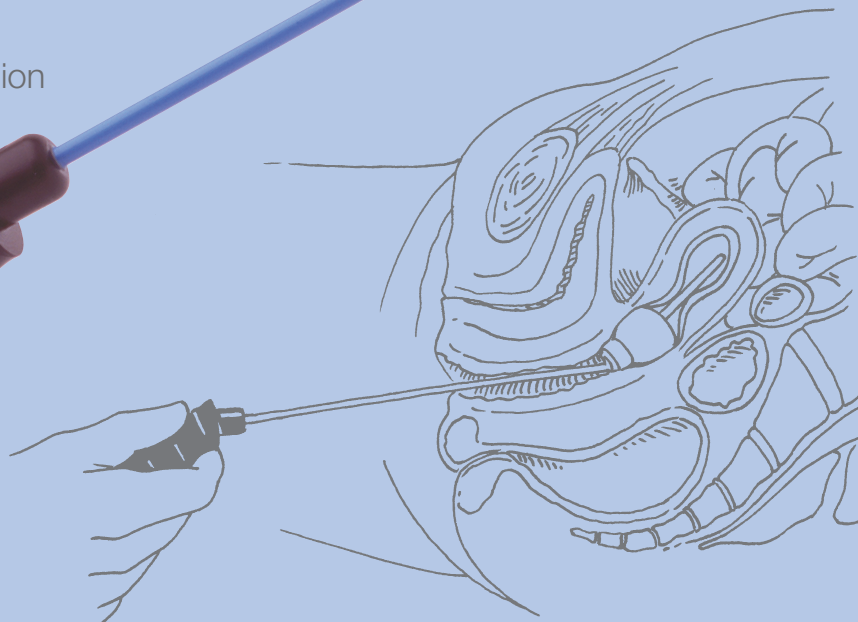
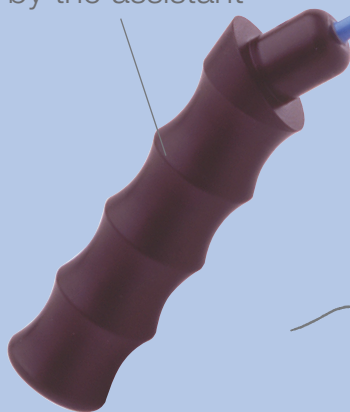

Coated for isolation



- Standard 3,5 cm internal diameter cup
- Transparent cup for visualisation during initial placement
- Cup design allows exposure of anatomical structures
- Isolated cup maintains pneumoperitoneum during most of colpotomy

Next200

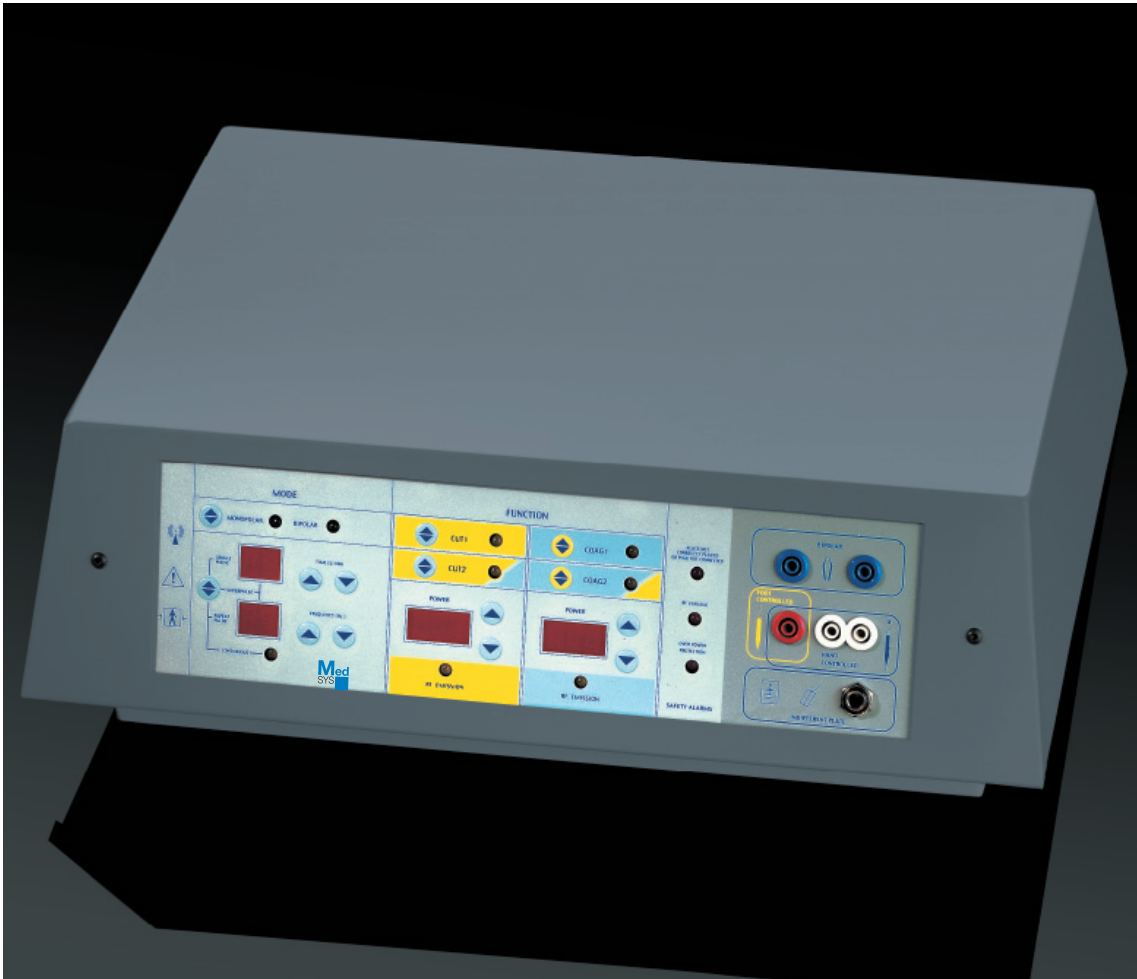

The Next Mono-Bipolar ElectroSurgical System for clinics, offices and operating rooms

Unique Single Pulse ■
Repeat Pulse ■
Super Pulse Modes ■

Less heat diffusion ■
Many applications ■
Easy to operate ■

GYNAECOLOGY / DERMATOLOGY / GENERAL SURGERY /
ENT / PLASTIC SURGERY

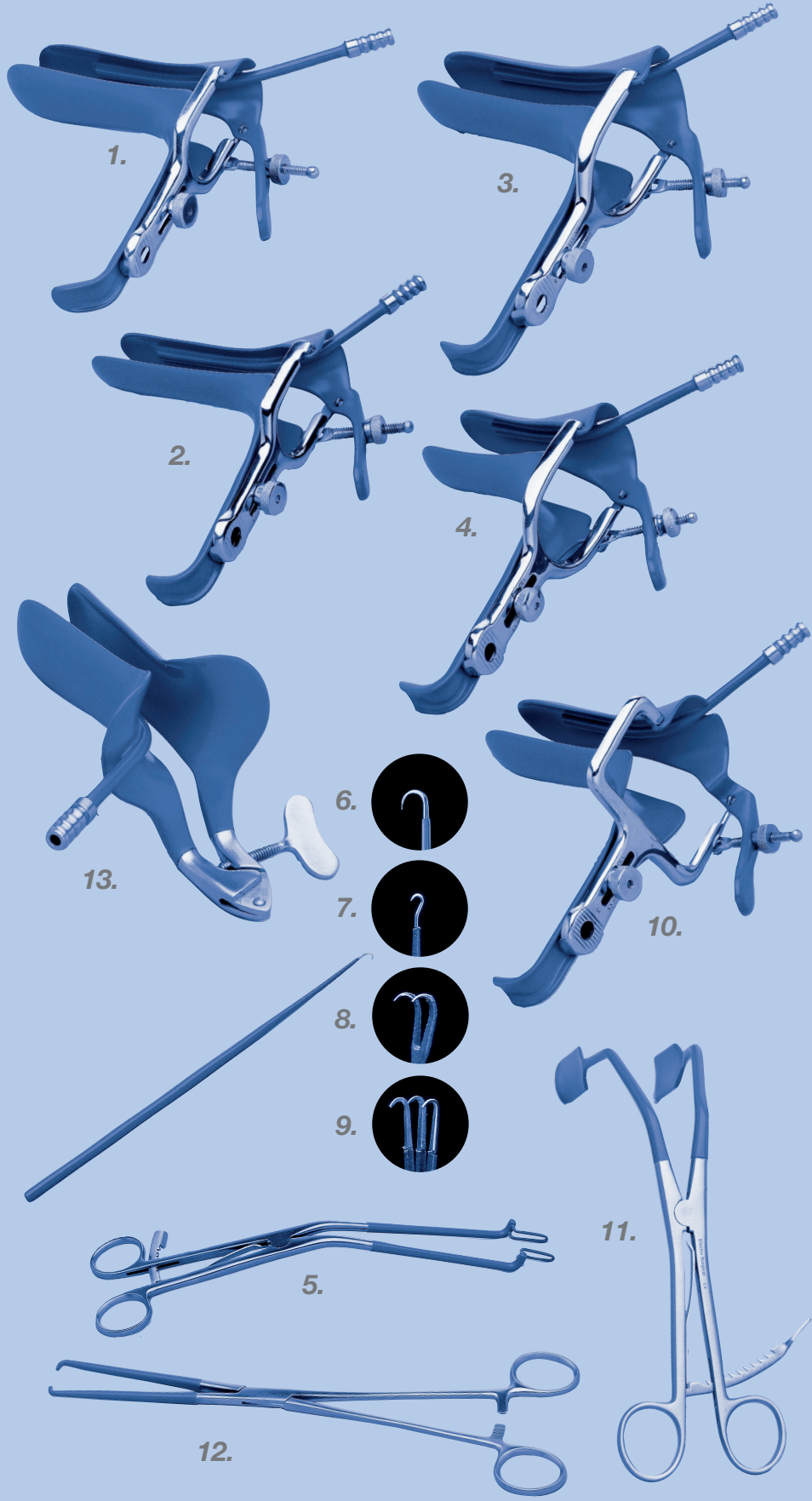

Non-Conductive Electrosurgical Instruments & Specula

- 1.** Graves Speculum with smoke tube
Item n°130-100 (Lg.)
Item n°130-101 (Med.)
Item n°130-102 (Sml.)
- 2.** Pederson Speculum with smoke tube
Item n°130-103 (Lg.)
Item n°130-104 (Med.)
Item n°130-105 (sml.)
- 3.** See-More Speculum with smoke tube Item n°130-110 (Lg.)
Item n°130-111 (Med.)
Item n°130-109 (Sml.)
- 4.** Mini See-More Speculum with smoke tube
Item n°130-113
Blade Size: L 70 x W 30mm
- 5.** Kogan Endocervical Speculum
Item n°130-130 (5mm, tips)
Item n°130-131 (4mm, tips)
Item n°133-132 (6mm, tips)
- 6.** Emmett Hook Item n°130-151
- 7.** Iris Hook Item n°130-150
- 8.** Two-Prong Hook Item n°130-154
- 9.** Three-Prong Hook Item n°130-155
- 10.** See-More Speculum with smoke tube
Item n°130-112 (XL)
- 11.** Lateral Vaginal Retractor
Item n°130-141
- 12.** Schroeder Tenaculum
Item N°130-160 (Exposed tips)
Item n°130-161 (coated tips)
- 13.** Collin Speculum with smoke tube
Item n°130-120 (Sml.)
Item n°130-121 (Med.)
Item n°130-122 (Lg.)

- All specula incorporate a smoke evacuation tube.
- All instruments are protected by the highest quality, fully autoclavable blue coating.

All these coated instruments are also available in black (anti-reflexion) for use with lasers.



Universal Electrosurgical Electrodes and Accessories

Reusable Handle
Foot Activated



Item n°110-006



Item n°110-007

Reusable Handle
Hand Activated



Item n°110-014

Pincer Cable
for interconnection
(Specificity E.S. Generator)
Item n°110-009



Disposable
Dispersive Pads
(box of 10)
Item n°110-008

* Sterile
disposable
Item #

Reusable
Item #

120-001

120-001 R

0,3 cm dia x 13 cm Shaft



120-002

120-002 R

0,5 cm dia x 13 cm Shaft



120-010

120-010 R

Needle 0.8 mm dia x 16 mm x 13 cm Shaft



120-011

120-011 R

Needle 0.8 mm dia x 16 mm x 13 cm Shaft



120-020

120-020 R

1.0 cm x 0.5 cm x 13 cm Shaft

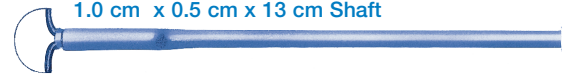

120-021

120-021 R

1.0 cm x 1.0 cm x 13 cm Shaft



120-022

120-022 R

1.5 cm x 0.8 cm x 13 cm Shaft



120-026

120-026 R

1.5 cm x 1.5 cm x 13 cm Shaft

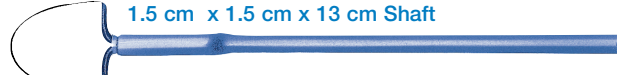

120-023

120-023 R

2.0 cm x 0.8 cm x 13 cm Shaft



120-033

120-033 R

2.0 cm x 1.0 cm x 13 cm Shaft



120-027

120-027 R

2.0 cm x 1.3 cm x 13 cm Shaft



120-024

120-024 R

2.0 cm x 1.5 cm x 13 cm Shaft



120-028

120-028 R

2.0 cm x 2.0cm x 13 cm Shaft



120-030

120-030 R

1.0 cm x 0.4 cm x 5.5 cm Shaft



120-031

120-031 R

1.0 cm x 0.8 cm x 13 cm Shaft

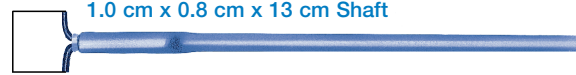

120-032

120-032 R

1.0 cm x 0.4 cm x 13 cm Shaft



120-042

120-042 R

13 cm Blade



ElectoSurgical Bipolar Forceps



180-101
1 mm
19 cm



180-100
Pointed
19 cm



180-110
1 mm
19 cm



180-111
2 mm
19 cm



180-120
Pointed
19 cm



180-121
1 mm
19 cm



180-122
2 mm
19 cm



180-131
Blunt
10,5 cm



180-140
Pointed
10,5 cm



180-141
Blunt
10,5 cm



180-130
Pointed
10,5 cm



180-200

- Highest quality
- Autoclavable at 134°C
- Guide stop for permanent alignment
- European standard flat-connector
- Non-conductive coating
- For precise surgery
- Autoclavable cable with small plugs
- Individually packed non sterile
- Autoclavable
- Available sterile disposable on request

Illustrations show approximate size

ElectoSurgical Reusable Electrodes

Ball Electrodes



125-001 Ø 3 mm Total length 5cm



125-002 Ø 5 mm Total length 5cm

Needle Electrodes



125-011 Fine Ø 0,8 mm x 17 mm Total length 7cm



125-011A Fine Ø 0,8 mm x 17 mm Angled



125-016 Ø 1 mm



125-016MF Ø 1 mm



125-017 Ø 1,7 mm

Ring Electrodes



125-025 Ø 5 mm Shaft length 4,5cm



125-020 Ø 6 mm Shaft length 4,5cm



125-021 Ø 8 mm Shaft length 4,5cm



125-022 Ø 10 mm Shaft length 4,5cm



125-023 Ø 12 mm Shaft length 4,5cm



125-026 Ø 15 mm Shaft length 4,5cm



125-024 Ø 20 mm Shaft length 4,5cm

Blade Electrodes



125-040 Blade Total length 7cm

125-040MF Blade Total length 7cm

125-041 Blade Total length 7cm

Cervix dilators

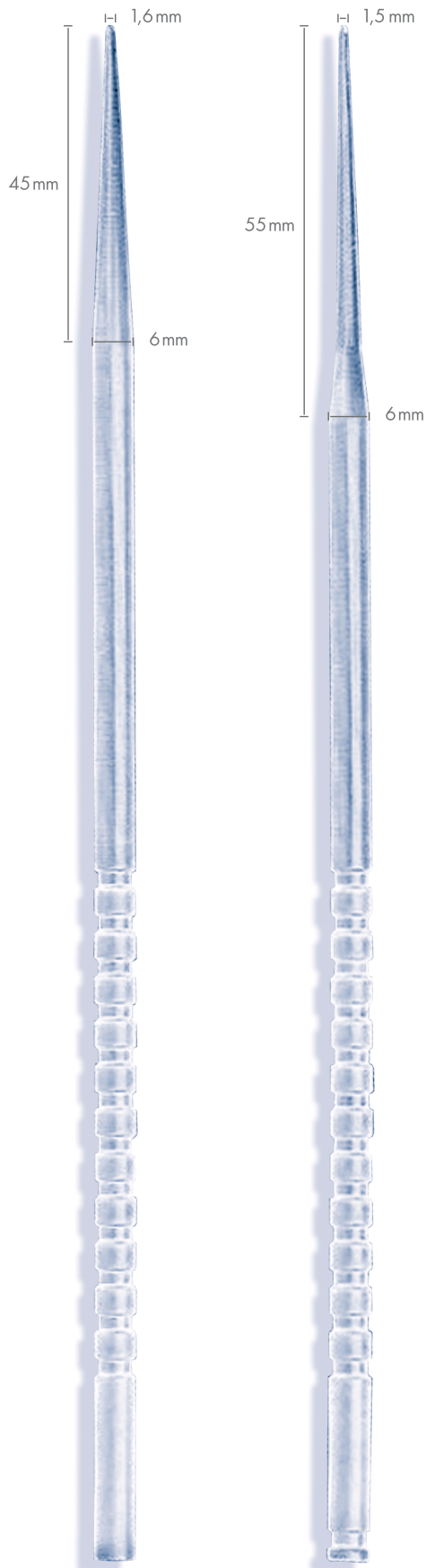

Cervix Dilator Quick
Ref. 260-700
(box of 50)

Cervix Dilator Slow
Ref. 260-600
(box of 50)

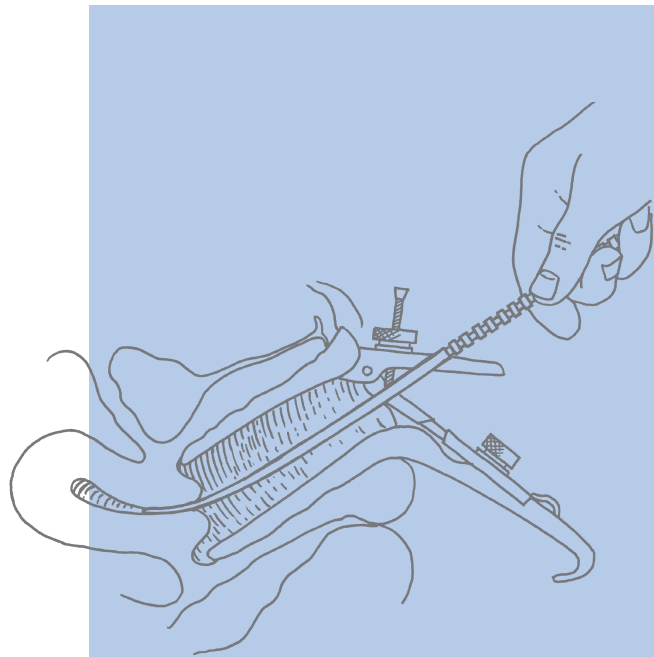

- gentle dilation of the stenotic os
- use prior to hysteroscopy, placement of IUD, endometrial biopsy
- single use, sterile packed
- two models :
 - Cervix Dilator Slow
Ref. 260-600
dilates from 1,5 -> 6mm over 55mm.
 - Cervix Dilator Quick
Ref. 260-700
dilates from 1,6 -> 6mm over 45mm.

Endometrial Samplers and dilators



MES (Medsys Endometrial Sampler) (280-725)

- For maximum patient safety and comfort
- Optimum sample recovery
- 3mm plus O.D. for ample biopsy
- Double O-ring mechanism assures optimal suction

MES (Medsys Endometrial Sampler with Syringe) (280-655)

- Randall-like cutting edge assures sample
 - Syringe provides extra vacuum
 - Convenient 3mm O.D
- Angled for left or right cornual selection



Cervix Needle

This needle was specifically designed to solve the problem of applying injections to the cervix. Distance and tough cervical tissue can make injection difficult with standard needles. With its reinforced and extended shaft, the Cervix Needle makes cervical application an easy procedure. The Cervix Needle only attaches to a "dental style" cartridge syringe.

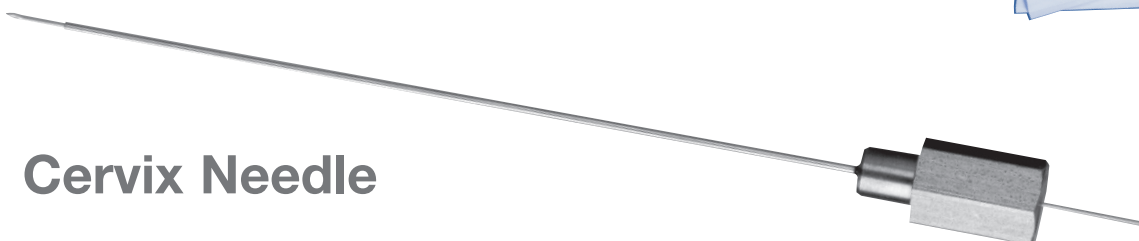

Item n° 606-600
Box of 6
Available on request :
cartridge syringe
Item n° 607-000

Biopsy forceps

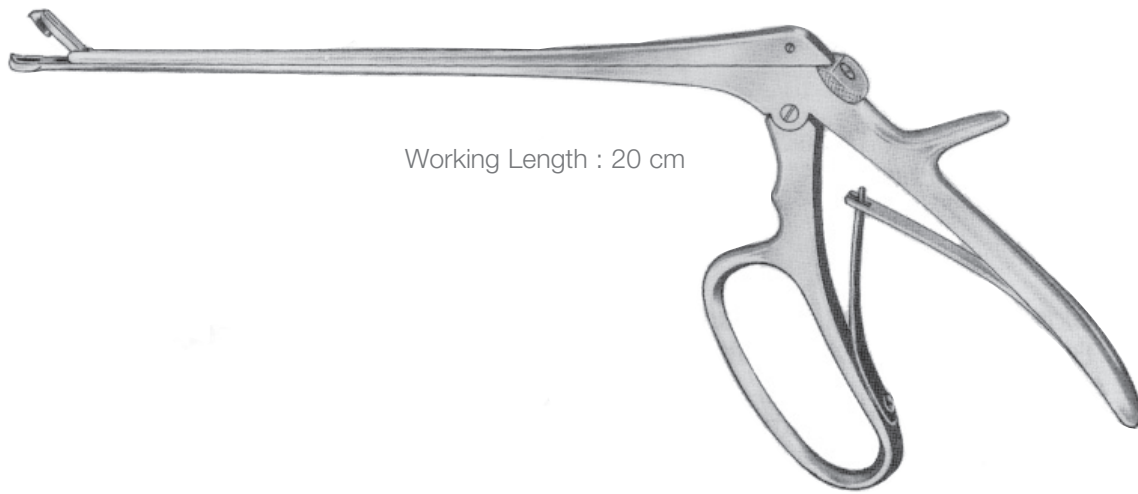

Working Length : 20 cm



○ 7x3 mm
TISCHLER
Item n°160-170



□ 3x9 mm
KEVORKIAN
Item n°160-172



⊂ 2,3x4 mm
BABY TISCHLER
Item n°160-171



○ 3x5 mm
BURKE STYLE
Item n°160-174

■ Available on request :

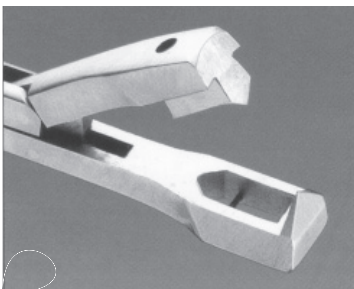

7mmx3mm
Item n°160-175

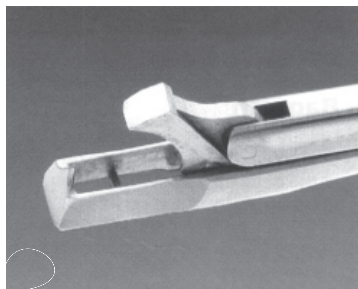

4mmx2,3mm
Item n°160-176

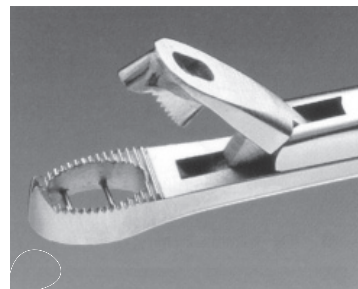

6,5mmx4mm
Item n°160-177

Biopsy forceps with rotating shaft

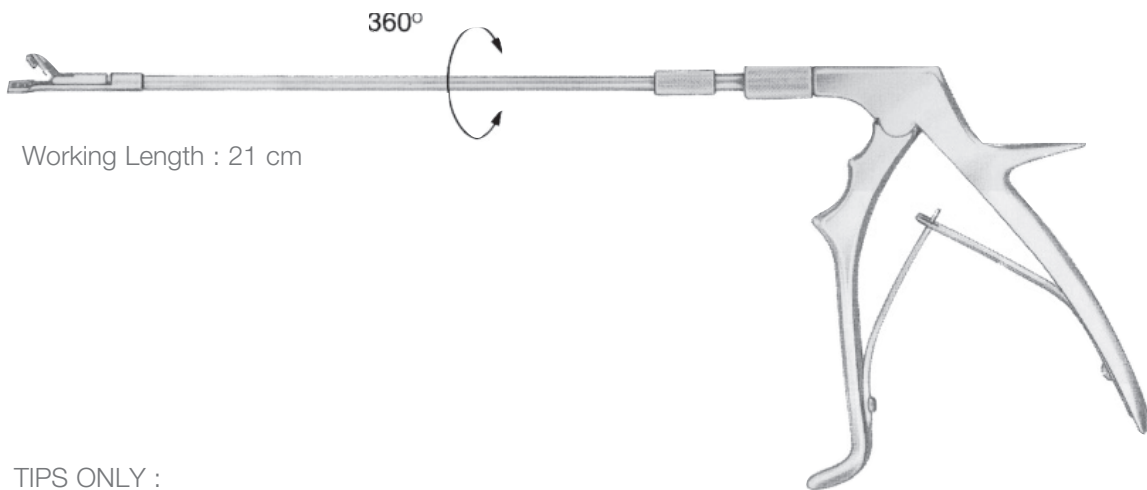

Working Length : 21 cm

TIPS ONLY :

- Item n°160-181 KEVORKIAN
- Item n°160-182 TISCHLER
- Item n°160-183 BABY TISCHLER
- Item n°160-184 OVAL

HANDLE ONLY :

- Item n°160-180



○ 3x7 mm
TISCHLER
Item n°160-186



□ 3x9 mm
KEVORKIAN
Item n°160-185



□ 2,3x4 mm
BABY TISCHLER
Item n°160-187



○ 3x5 mm
OVAL
Item n°160-188

Biopsy Forceps

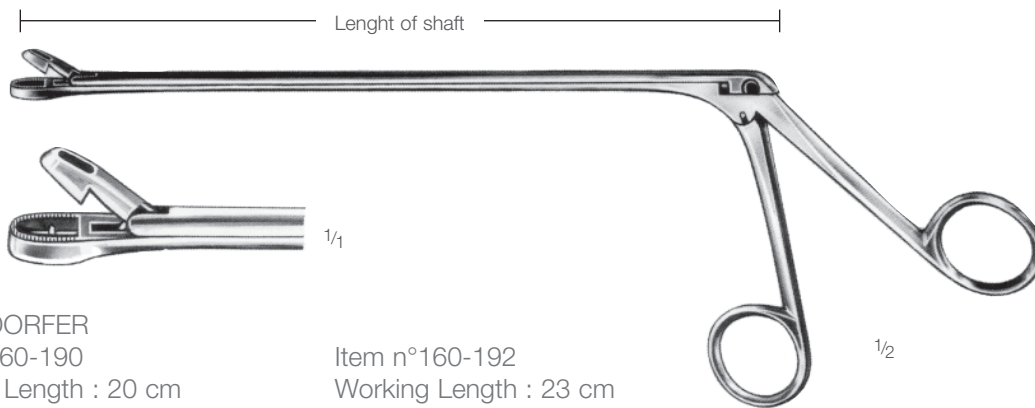

EPPENDORFER
Item n°160-190
Working Length : 20 cm

Item n°160-192
Working Length : 23 cm

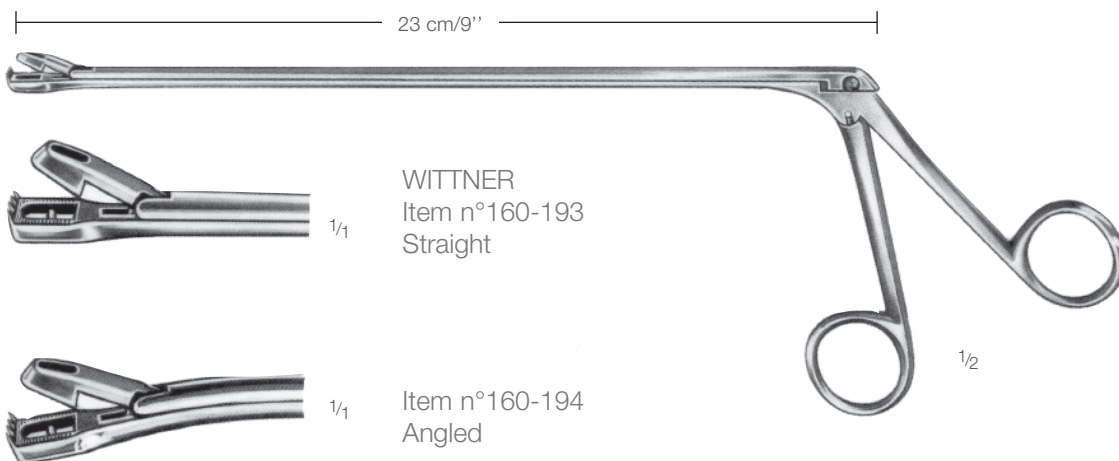

WITTNER
Item n°160-193
Straight

Item n°160-194
Angled

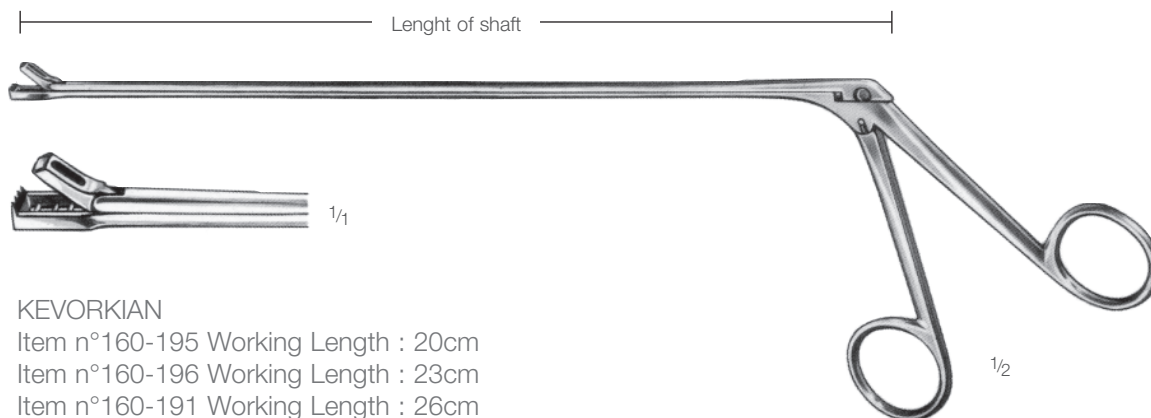

KEVORKIAN
Item n°160-195 Working Length : 20cm
Item n°160-196 Working Length : 23cm
Item n°160-191 Working Length : 26cm

Biopsy forceps



SCHUBERT
Item n°160-201
Working Length : 20 cm

SCHUBERT
Item n°160-202 21 cm
Item n°160-203 29 cm



VAN DOREN
Item n°160-205 24 cm
With Ratchet



VAN DOREN
Item n°160-204
24 cm

Endocervical and endometrial curettes



Ø 4 mm

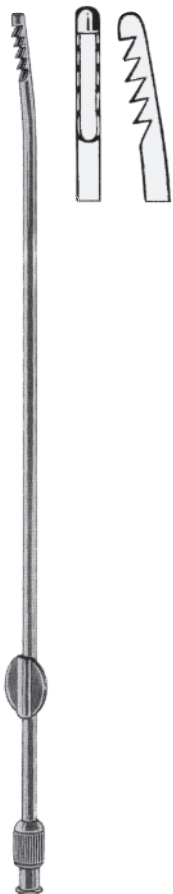

NOVAK
 Item n°160-213 1 mm
 Item n°160-210 2 mm
 Item n°160-211 3 mm
 Item n°160-212 4 mm



MINI-KERVORKIAN
 Item n°160-223



ENDOCURETTE
 Item n°160-224 30 cm

Works by rotating



Item n°160-221

Item n°160-220

Item n°160-222

KEVORKIAN

Uterine curettes and sounds

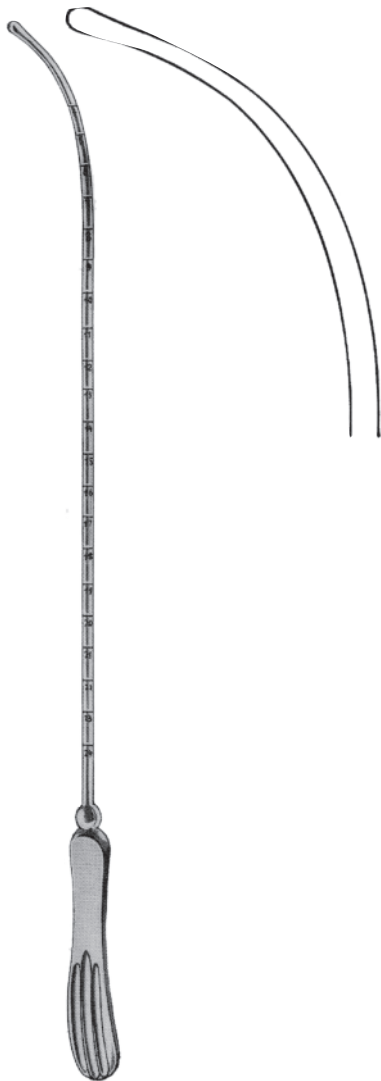

SIMS
With graduation in cm
Item n°160-298 Malleable 32 cm
Item n°160-299 Rigid 32 cm



Fig 1



Fig 2



Fig 3



Fig 4



Fig 5

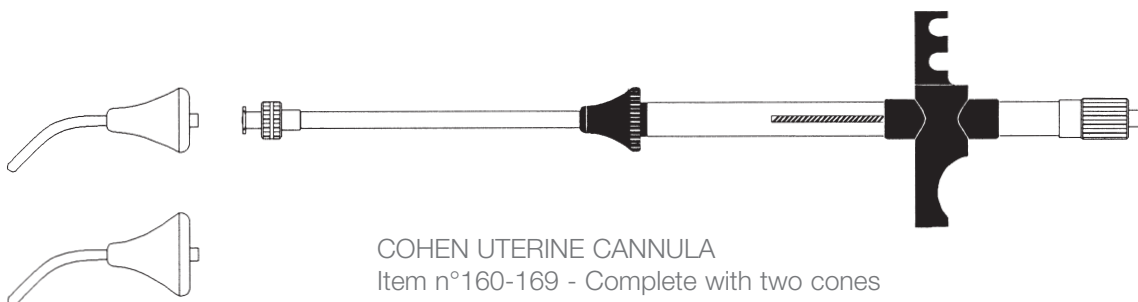

Fig 6

SIMS
24,5-26 cm long
Sharp



	Rigid	Malleable
Item n° 160-250	fig.1 : 7mm	160-256
Item n° 160-251	fig.2 : 8mm	160-257
Item n° 160-252	fig.3 : 9mm	160-258
Item n° 160-253	fig.4 : 11mm	160-259
Item n° 160-254	fig.5 : 12mm	160-260
Item n° 160-255	fig.6 : 14mm	160-261



COHEN UTERINE CANNULA
Item n°160-169 - Complete with two cones
Item n°160-169 A - Cone diam. 19,0mm/3,0mm
Item n°160-169 B - Cone diam. 25,0mm/3,0mm

Tenaculum forceps and hooks

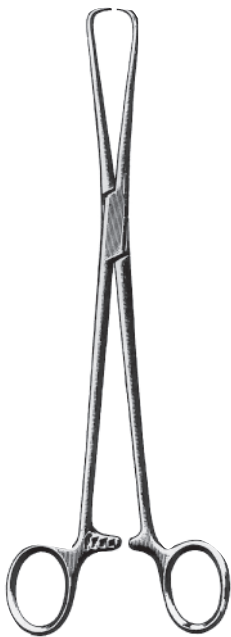

SCHROEDER
Item n°160-160
25 cm



BRAUN
Item n°160-161
25 cm

KEYES VULVAR PUNCHES



- Item n°160-402 2 mm
- Item n°160-403 3 mm
- Item n°160-404 4 mm
- Item n°160-405 5 mm
- Item n°160-406 6 mm
- Item n°160-408 8 mm
- Item n°160-400 SET
Six sizes 2-8 mm

HOOKS



EMMET
Item n°160-151



LASER IRIS
Item n°160-153



IRIS
Item n°160-150



Item n°160-154
Two-Prong Hook



Item n°160-155
Three-Prong Hook

Lateral vaginal retractor and speculums

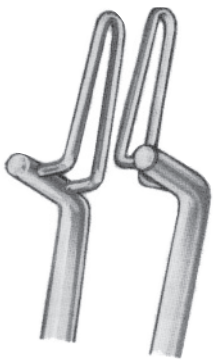

Item n°160-132
5mm

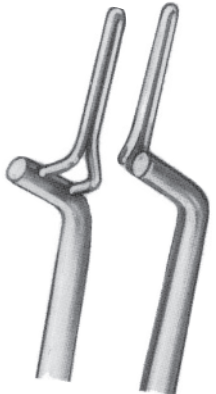

Item n°160-130
3 mm



KOGAN
Item n°160-131
4 mm

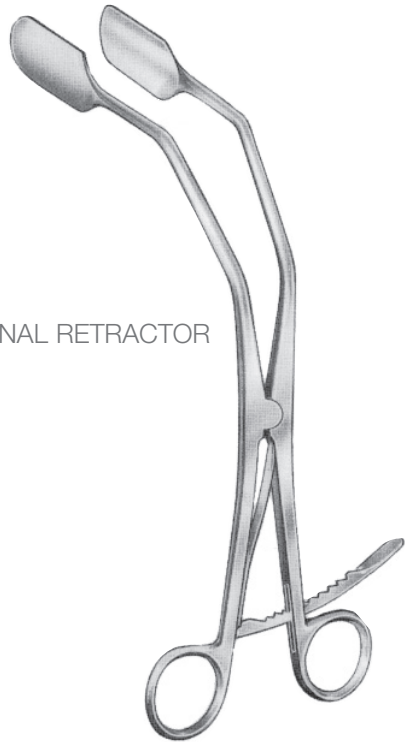

LATERAL VAGINAL RETRACTOR
Item n°160-141

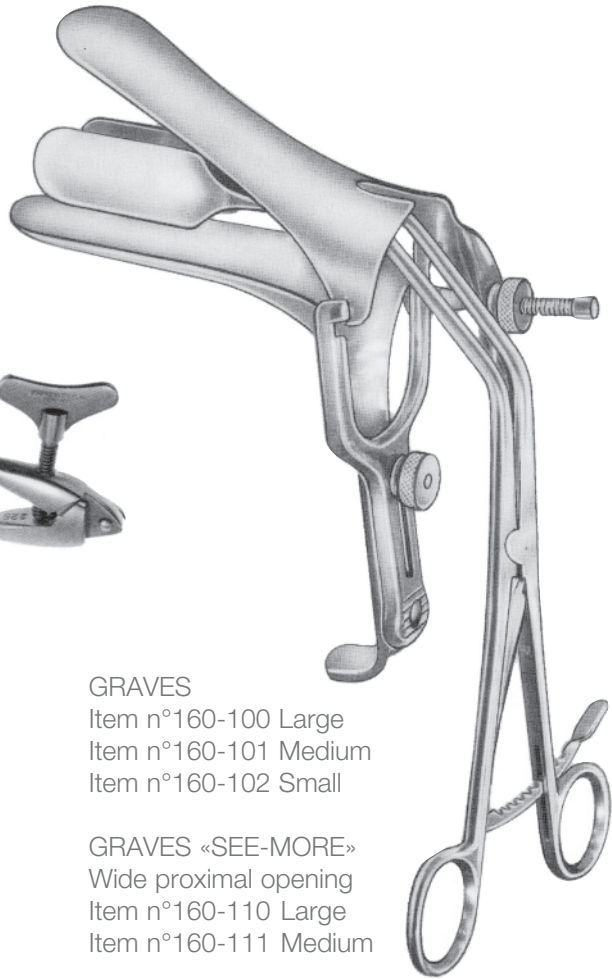

GRAVES
Item n°160-100 Large
Item n°160-101 Medium
Item n°160-102 Small

GRAVES «SEE-MORE»
Wide proximal opening
Item n°160-110 Large
Item n°160-111 Medium



COLLIN
Item n°160-120 Small
Item n°160-121 Medium
Item n°160-122 Large

Lateral vaginal retractor and speculums



CUSCO		Item n°	
a mm	b mm		
75	17	160-127	Virgin Size



CUSCO		Item n°	
a mm	b mm		
75	32	160-124	Small
85	35	160-125	Medium
100	35	160-126	Large



Redundant wall retractor
Item n° 160-140

Vulsellum and sponge forceps

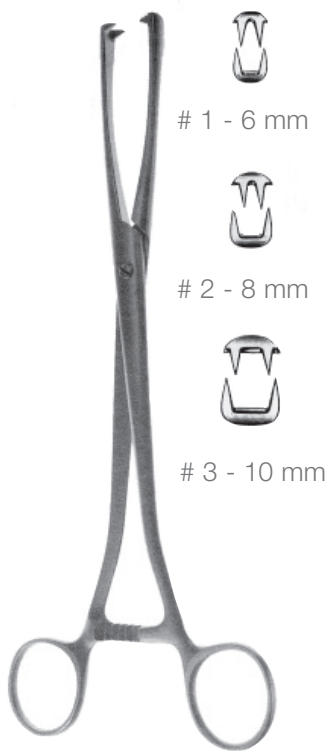

MUSEUX
 Item n°040-001 # 1
 Item n°040-002 # 2
 Item n°040-003 # 3
 24 cm

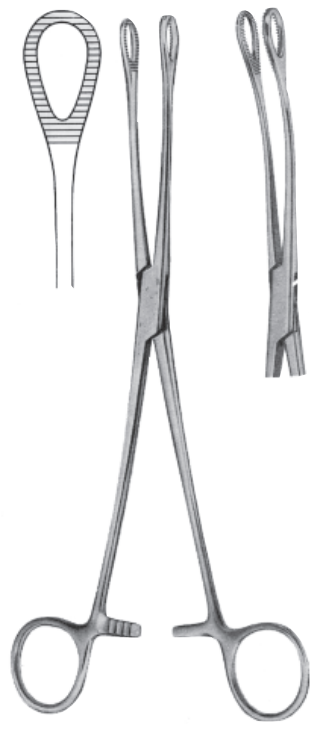

FOERSTER
 Item n°040-024
 24 cm



FOERSTER
 Item n°040-124
 24 cm



BOZEMANN
 Item n°040-226
 26 cm



DESJARDIN
 Item n°160-134
 23 cm



MAIER
 Item n°040-326 straight
 Item n°040-426 curved
 26 cm

Scissors



blunt/blunt straight
 Item n°000-013 13 cm
 Item n°000-014 14 cm
 Item n°000-015 15 cm
 Item n°000-016 16 cm
 Item n°000-018 18 cm



sharp/sharp straight
 Item n°000-113 13 cm
 Item n°000-114 14 cm
 Item n°000-115 15 cm
 Item n°000-116 16 cm
 Item n°000-118 18 cm



sharp/blunt straight
 Item n°000-213 13 cm
 Item n°000-214 14 cm
 Item n°000-215 15 cm
 Item n°000-216 16 cm
 Item n°000-218 18 cm



blunt/blunt curved
 Item n°000-313 13 cm
 Item n°000-314 14 cm
 Item n°000-315 15 cm
 Item n°000-316 16 cm
 Item n°000-318 18 cm



sharp/sharp curved
 Item n°000-413 13 cm
 Item n°000-414 14 cm
 Item n°000-415 15 cm
 Item n°000-416 16 cm
 Item n°000-418 18 cm



sharp/blunt curved
 Item n°000-513 13 cm
 Item n°000-514 14 cm
 Item n°000-515 15 cm
 Item n°000-516 16 cm
 Item n°000-518 18 cm

Scissors



METZENBAUM
(LAHEY)
Item n° 003-015
14cm



METZENBAUM
(LAHEY)
Item n° 003-115
14cm



METZENBAUM
Item n°
003-018-18cm
Item n°
003-020-20cm



METZENBAUM
Item n°
003-118-18cm
Item n°
003-120-20cm

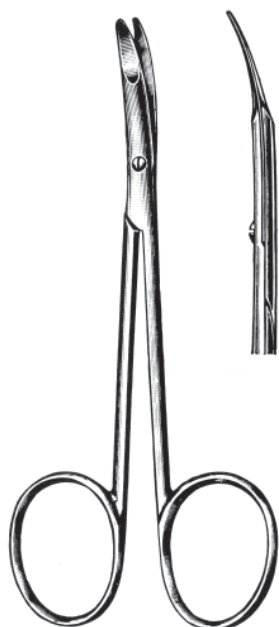

RAGNELL (KILNER)
Item n° 003-913 - 13cm
Item n° 003-915 - 15cm



BRAUN-STADLER
Item n° 003-815 - 15cm



BRAUN-STADLER
Item n° 003-821 - 21cm

Scissors



MAYO
 Item n° 000-614 - 14cm
 Item n° 000-615 - 15,5cm
 Item n° 000-617 - 17cm
 Item n° 000-623 - 23cm



MAYO-STILLE
 Item n° 000-815 - 15cm
 Item n° 000-817 - 17cm
 Item n° 000-823 - 23cm



MAYO
 Item n° 000-714 - 14cm
 Item n° 000-715 - 15,5cm
 Item n° 000-717 - 17cm
 Item n° 000-723 - 23cm



MAYO-STILLE
 Item n° 000-915 - 15cm
 Item n° 000-917 - 17cm
 Item n° 000-923 - 23cm

Scissors

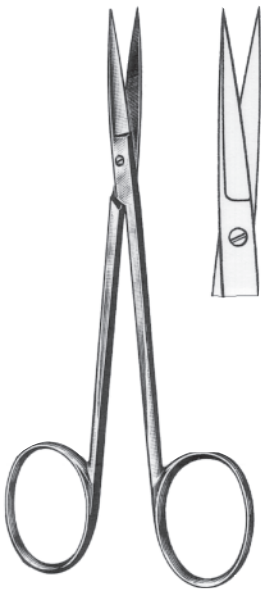

IRIS Standard
Straight
Item n°002-009 9,0 cm
Item n°002-010 10,5 cm
Item n°002-011 11,5 cm
Item n°002-012 12,5 cm



IRIS Standard
Curved
Item n°002-109 9,0 cm
Item n°002-110 10,5 cm
Item n°002-111 11,5 cm
Item n°002-112 12,5 cm

SIMS
sharp/sharp straight
Item n°001-220 20,0 cm
Item n°001-221 21,5 cm
Item n°001-223 23,0 cm



SIMS
sharp/blunt straight
Item n°001-120 20,0 cm
Item n°001-121 21,5 cm
Item n°001-123 23,0 cm



SIMS
blunt/blunt straight
Item n°001-020 20,0 cm
Item n°001-021 21,5 cm
Item n°001-023 23,0 cm

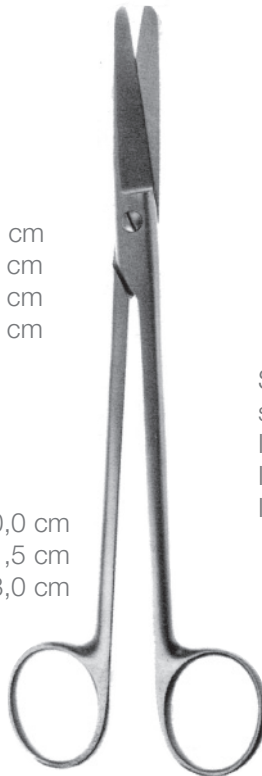

SIMS
blunt/blunt curved
Item n°001-320 20,0 cm
Item n°001-321 21,5 cm
Item n°001-323 23,0 cm



SIMS
sharp/blunt curved
Item n°001-520 20,0 cm
Item n°001-521 21,5 cm
Item n°001-523 23,0 cm



SIMS
sharp/sharp curved
Item n°001-420 20,0 cm
Item n°001-421 21,5 cm
Item n°001-423 23,0 cm



Parametrium Scissors



Strongly Curved w/ Gold Rings

410-223 23cm
410-226 26.5cm
410-230 30cm



Slightly Curved w/ Gold Rings

410-123 23cm
410-126 26.5cm
410-130 30cm

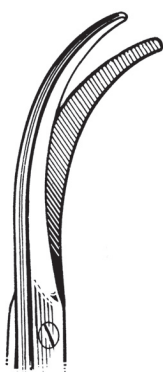

Angulated w/ Gold Rings

410-323 23cm
410-326 26.5cm
410-330 30cm

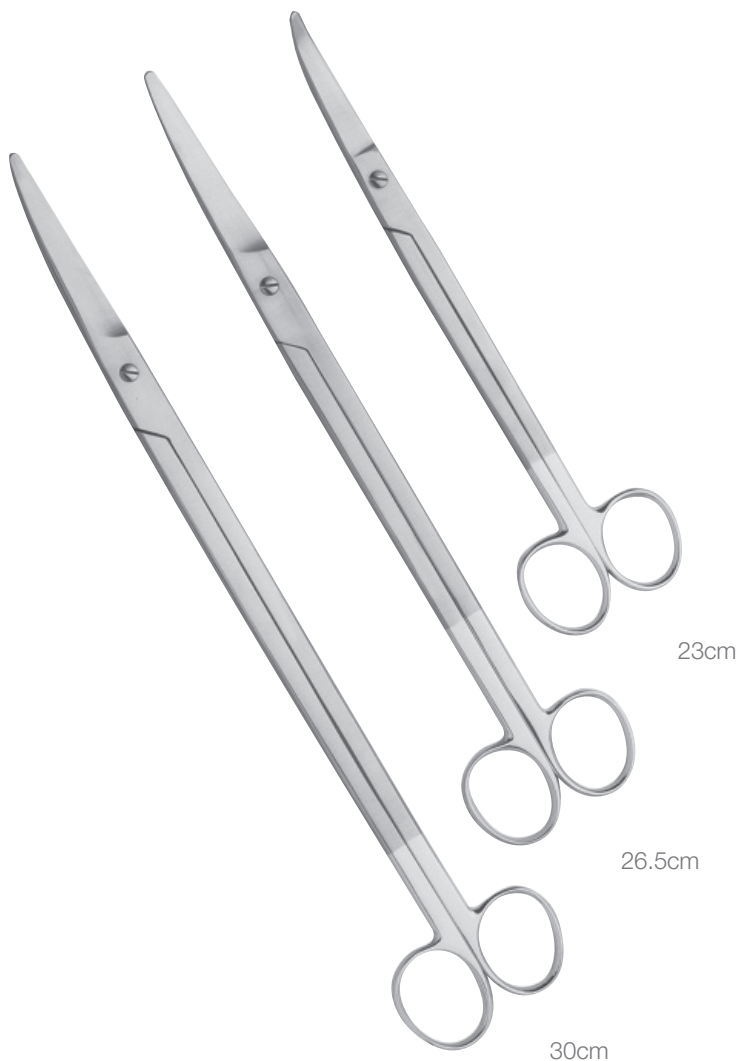

Parametrium scissors are a complete set of parametrium scissors designed to match precisely to the special hysterectomy clamp jaw curvatures. The scissors guarantee precise cutting. The scissors feature a tungsten blade and a serrated blade to ensure grip during cutting. The scissors are available in three lengths and three jaw configurations.

Dissecting forceps

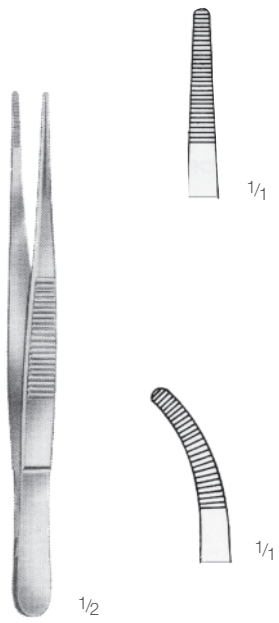

Straight
 Item n°010-011 11,5 cm
 Item n°010-013 13,0 cm
 Item n°010-014 14,5 cm
 Item n°010-016 16,0 cm
 Item n°010-018 18,0 cm
 Item n°010-020 20,0 cm
 Item n°010-023 23,0 cm
 Item n°010-025 25,0 cm
 Item n°010-030 30,0 cm

Curved
 Item n°011-011 11,5 cm
 Item n°011-013 13,0 cm
 Item n°011-014 14,5 cm
 Item n°011-016 16,0 cm
 Item n°011-018 18,0 cm
 Item n°011-020 20,0 cm
 Item n°011-023 23,0 cm
 Item n°011-025 25,0 cm
 Item n°011-030 30,0 cm

Straight
 Item n°012-011 11,5 cm
 Item n°012-013 13,0 cm
 Item n°012-014 14,5 cm
 Item n°012-016 16,0 cm
 Item n°012-018 18,0 cm
 Item n°012-020 20,0 cm
 Item n°012-025 25,0 cm
 Item n°012-030 30,0 cm

Curved
 Item n°013-011 11,5 cm
 Item n°013-013 13,0 cm
 Item n°013-014 14,5 cm
 Item n°013-016 16,0 cm
 Item n°013-018 18,0 cm
 Item n°013-020 20,0 cm
 Item n°013-025 25,0 cm
 Item n°013-030 30,0 cm

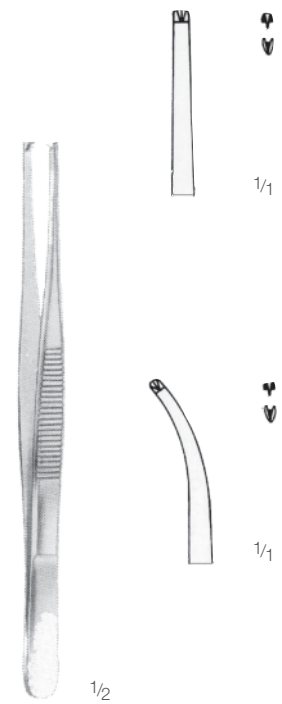

DE BAKEY



Item n°014-016 16,0 cm
 Item n°014-020 20,0 cm
 Item n°014-024 24,0 cm



Item n°015-016 16,0 cm
 Item n°015-020 20,0 cm
 Item n°015-024 24,0 cm
 Item n°015-030 30,0 cm

Hemostatic forceps



CRILE
Item n°
020-010 020-011
14cm 14cm



RANKIN-CRILE
Item n°
020-410 020-411
16cm 16cm



CRILE
Item n°
020-012 020-013
14cm 14cm
1x2 teeth



RANKIN-CRILE
Item n°
020-412 020-413
16cm 16cm
1x2 teeth



HALSTED-MOSQUITO
Item n°
020-002 020-004
12,5cm 12,5cm



HALSTED-MOSQUITO
Item n°
020-003 020-005
14cm 14cm



HALSTED-MOSQUITO
Item n°
020-006 020-008
12,5cm 12,5cm
1x2 teeth

Hemostatic forceps

ROCHESTER-PEAN

Straight

Item n°020-016 16,0 cm

Item n°020-018 18,0 cm

Item n°020-020 20,0 cm

Item n°020-022 22,0 cm

Item n°020-024 24,0 cm

Item n°020-026 26,0 cm



16 cm



18 cm



20 cm



22 cm
24 cm



26 cm



ROCHESTER-PEAN

Curved

Item n°020-116 16,0 cm

Item n°020-118 18,0 cm

Item n°020-120 20,0 cm

Item n°020-122 22,0 cm

Item n°020-124 24,0 cm

Item n°020-126 26,0 cm



16 cm



18 cm



20 cm



22 cm
24 cm



26 cm



Hemostatic forceps

KOCHER

Straight

Item n°020-216 16,0 cm

Item n°020-218 18,0 cm

Item n°020-220 20,0 cm

Item n°020-222 22,0 cm

Item n°020-224 24,0 cm

Item n°020-226 26,0 cm

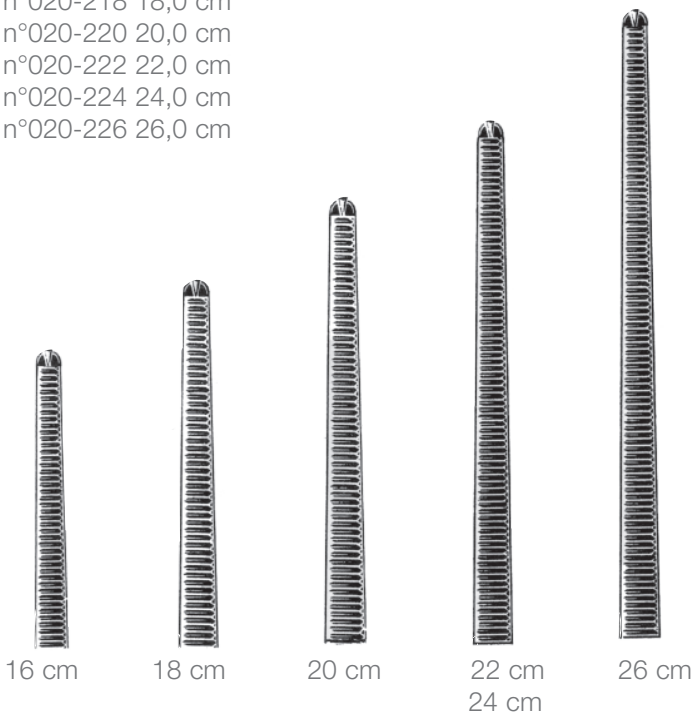

KOCHER

Curved

Item n°020-316 16,0 cm

Item n°020-318 18,0 cm

Item n°020-320 20,0 cm

Item n°020-322 22,0 cm

Item n°020-324 24,0 cm

Item n°020-326 26,0 cm

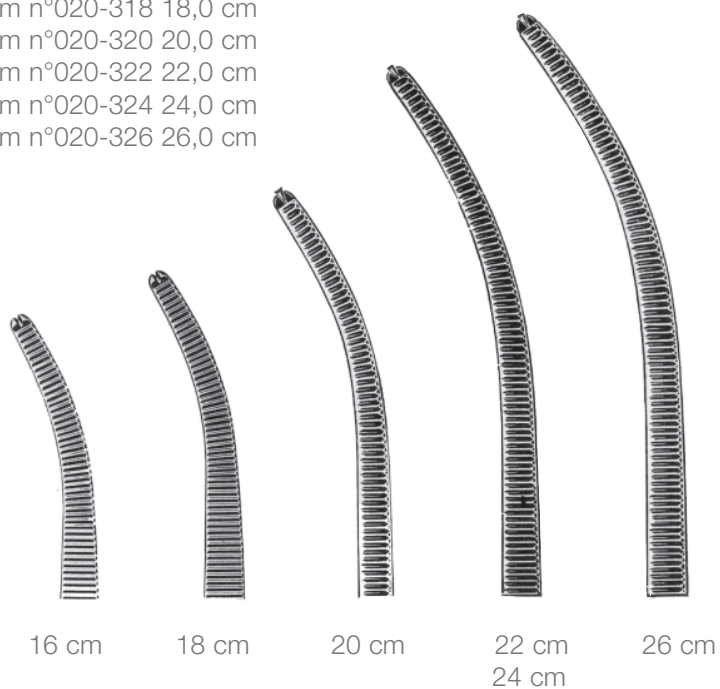

Clamp forceps



Item n°030-421



Item n°030-521



FAURE
21 cm



Item n°030-025
25 cm



Item n°030-124
24,5 cm



Item n°030-224
24 cm



Item n°030-323
23 cm

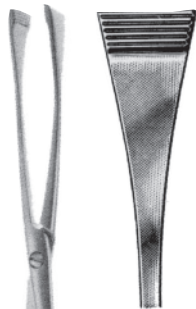

GREEN-ARMYTAGE
Item n° 030-622
22 cm



WERTHEIM

Special Hysterectomy Clamps



Straight w/ Gold Rings

- 336-411 21cm
- 336-541 24cm
- 336-601 30cm
- 336-661 35cm



Angulated w/ Gold Rings

- 336-414 21cm
- 336-544 24cm
- 336-604 30cm
- 336-664 35cm

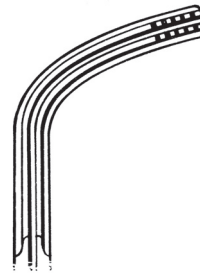

Slightly Curved w/ Gold Rings

- 336-412 21cm
- 336-542 24cm
- 336-602 30cm
- 336-662 35cm

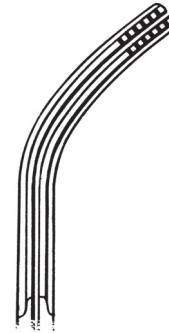

Strongly Curved w/ Gold Rings

- 336-413 21cm
- 336-543 24cm
- 336-603 30cm
- 336-663 35cm



All clamps available with angled or Gupta Frank-style shanks for greater scissoring space and clamping ability.

These clamps are well-balanced and have a sturdy, atraumatic longitudinal groove that guarantees a secure grip of tissue and prevents slippage. The hysterectomy clamps are available in four lengths and four jaw configurations.

Vaginal speculums



BREISKY
29 cm
160-350 100x20mm
160-351 100x25mm
160-352 100x30mm
160-353 100x35mm
160-354 100x40mm

BREISKY
32 cm
160-355 130x20mm
160-356 130x25mm
160-357 130x30mm
160-358 130x35mm
160-359 130x40mm

BREISKY
35 cm
160-360 160x20mm
160-361 160x25mm
160-362 160x30mm
160-363 160x35mm
160-364 160x40mm

BREISKY
37 cm
160-365 180x20mm
160-366 180x25mm
160-367 180x30mm
160-368 180x35mm
160-369 180x40mm

Vaginal speculums and retractors

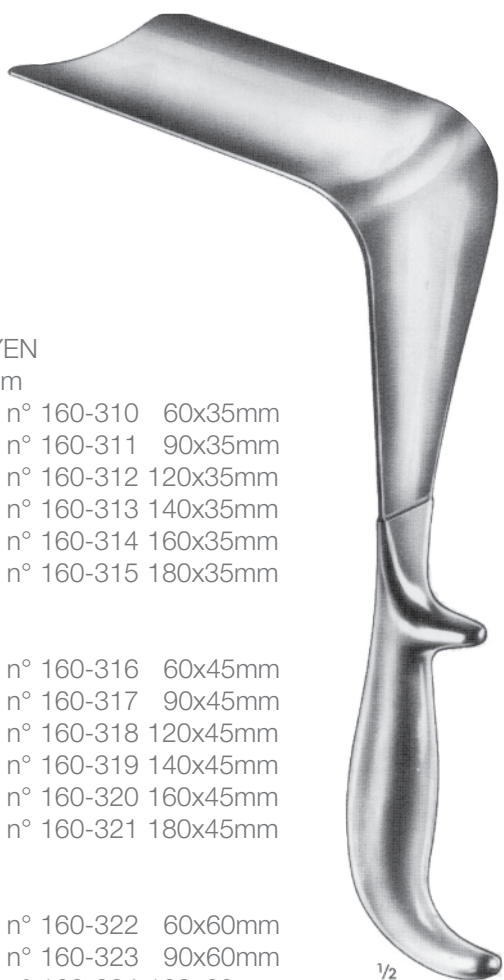

DOYEN

24 cm

Item n° 160-310 60x35mm
Item n° 160-311 90x35mm
Item n° 160-312 120x35mm
Item n° 160-313 140x35mm
Item n° 160-314 160x35mm
Item n° 160-315 180x35mm

Item n° 160-316 60x45mm
Item n° 160-317 90x45mm
Item n° 160-318 120x45mm
Item n° 160-319 140x45mm
Item n° 160-320 160x45mm
Item n° 160-321 180x45mm

Item n° 160-322 60x60mm
Item n° 160-323 90x60mm
Item n° 160-324 120x60mm
Item n° 160-325 140x60mm
Item n° 160-326 160x60mm
Item n° 160-327 180x60mm

SIMON

28 cm

Item n° 160-300 115x22mm
Item n° 160-301 115x27mm



1/2

Needle holders with tungsten carbide insert jaws

RYDER (FRENCH EYE)

2 mm

13 15 18 20 23 ^{1/1}

Item n° 050-013 13 cm
 Item n° 050-015 15 cm
 Item n° 050-018 18 cm
 Item n° 050-020 20 cm
 Item n° 050-023 23 cm

^{1/2}

MAYO-HEGAR

16 18 20 24 26 30 35 ^{1/1}

Item n° 050-116 16 cm
 Item n° 050-118 18 cm
 Item n° 050-120 20 cm
 Item n° 050-124 24 cm
 Item n° 050-126 26 cm

Item n° 050-130 30 cm
 Item n° 050-135 35 cm

Item n° 050-140 40 cm

^{1/2}

MAYO-HEGAR (HEANEY)

20 24 26 ^{1/1}

Item n° 050-220 20 cm
 Item n° 050-224 24 cm
 Item n° 050-226 26 cm

^{1/2}

Needle holders with tungsten carbide insert jaws



HALSEY
Item n° 050-001
13,5cm



CRILE-WOOD
Item n°050-315
15cm

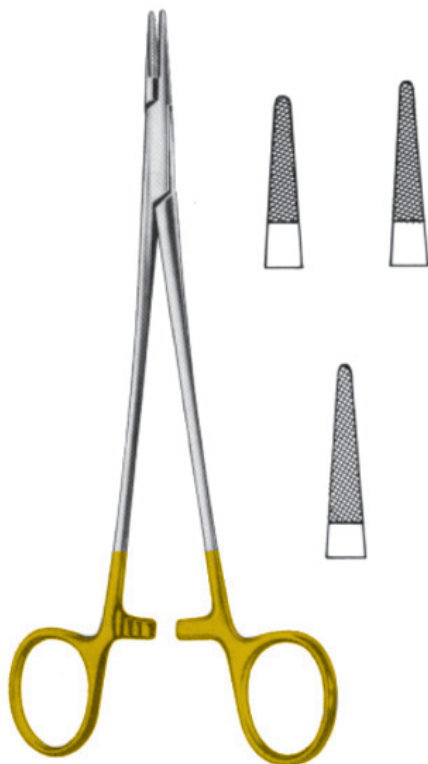

CRILE-WOOD (De Bakey)
Item n° 050-318 - 18cm
Item n° 050-320 - 20cm
Item n° 050-323 - 23cm

Monopolar insulated forceps and scissors



MAYO
Item n°

170-101 - 20cm
170-102 - 23cm



MAYO
Item n°

170-103 - 20cm
170-104 - 23cm



METZENBAUM
Item n°

170-105 - 18cm
170-106 - 20cm
170-107 - 23cm



Monopolar
cable for these
instruments.
Item n°170-108



GERALD
Item n°
170-005
18cm



GERALD
Item n°
170-006
18cm
(1 x 2)



Item n°
170-007-
18cm
170-008-
20cm
170-009-
25cm



DISSECTING FOR-
CEPS
SERRATED
Item n°
170-001-18cm
170-002-21cm
170-003-25cm
2mm tip width



ADSON BAYONET
SERRATED
Item n°
170-004-19cm
Long
2mm tip width

Look
inside

Comprehensive Family of Products for Operating Room and Private Offices

- Full range of electrosurgery electrodes developed and manufactured in house for all applications including gyn, dermatology, gen surgery, cardio vascular, maxillo-facial...
- LapMan® robot for laparoscope manipulation.
 - Speciality biopsy forceps.
- Next 200 electrosurgical generator and all its accessories.
- Large range of hysterectomy clamps and scissors.
 - Endometrial Samplers.
- Os finder, flexible and gentle cervical dilator for hysterectomy, endometrial biopsy...
- High quality needle holders with tungsten carbide insert jaws.

Medsys s.a. • 39, rue Chainisse
B-5030 Gembloux • Belgium
Tel. : +32 81 56 84 84 • Fax : +32 81 56 88 84
E-mail : info@medsys.be
[http:// www.medsys.be](http://www.medsys.be)



CUSCO-SUISSE VAGINAL SPECULA



reference	description	size	shape
70.160.02	CUSCO-SUISSE VAGINAL SPECULA	100 mm / 25 mm	pointed
70.160.03	CUSCO-SUISSE VAGINAL SPECULA	105 mm / 27 mm	pointed
70.160.01	CUSCO-SUISSE VAGINAL SPECULA	80 mm / 22 mm	pointed







CUSCO-VIRGIN VAGINAL SPECULA



reference	description	size	shape
70.142.00	CUSCO-VIRGIN VAGINAL SPECULA	75 mm / 17 mm	

HYSTEROSCOPY FORCEPS

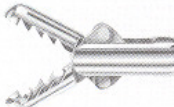

	Ø mm	Fr	Length 340 mm			Length 400 mm		
			Ordering number			Ordering number		
			Flexible	Flexible insulated	Semi-rigid	Flexible	Flexible insulated	Semi-rigid
PROBEEXZISIONSZANGE, oval, doppelbeweglich <i>BIOPSY FORCEPS,</i> oval, double action 	1,0	3	RF203-341		RF203-343	RF203-401		RF203-403
	1,6	5	RF205-341	RF205-342	RF205-343	RF205-401	RF205-402	RF205-403
	2,1	6	RF206-341	RF206-342	RF206-343	RF206-401	RF206-402	RF206-403
	2,3	7	RF207-341	RF207-342	RF207-343	RF207-401	RF207-402	RF207-403
SCHERE, flexibel, einfachbeweglich <i>SCISSORS, flexible,</i> single action 	1,6	5	RF215-341	RF215-342	RF215-343	RF215-401	RF215-402	RF215-403
	2,1	6	RF216-341	RF216-342	RF216-343	RF216-401	RF216-402	RF216-403
	2,3	7	RF217-341	RF217-342	RF217-343	RF217-401	RF217-402	RF217-403
HAKENSCHERE, flexibel, einfach- beweglich <i>HOOK SCISSORS,</i> flexible, single action 	2,3	7	RF227-341	RF227-342	RF227-343	RF227-401	RF227-402	RF227-403
SCHERE, flexibel, doppelbeweglich <i>SCISSORS, flexible,</i> double action 	2,3	7	RF237-341	RF237-342	RF237-343	RF237-401	RF237-402	RF237-403
PROBEEXZISIONSZANGE, flexibel, oval, gezahnt, doppelbeweglich <i>BIOPSY FORCEPS,</i> flexible, oval, serrated, 	1,6	5	RF245-341	RF245-342	RF245-343	RF245-401	RF245-402	RF245-403
	2,1	6	RF246-341	RF246-342	RF246-343	RF246-401	RF246-402	RF246-403
	2,3	7	RF247-341	RF247-342	RF247-343	RF247-401	RF247-402	RF247-403
FASSZANGE, flexibel, Alligatormaul, doppelbeweglich <i>GRASPING FORCEPS,</i> flexible, alligator jaw, 	1,0	3	RF253-341		RF253-343	RF253-401		RF253-403
	1,6	5	RF255-341	RF255-342	RF255-343	RF255-401	RF255-402	RF255-403
	2,3	7	RF257-341	RF257-342	RF257-343	RF257-401	RF257-402	RF257-403
FASSZANGE, flexibel, gezahnt, doppelbew. <i>GRASPING FORCEPS,</i> flexible, serrated, double action 	1,6	5	RF265-341	RF265-342	RF265-343	RF265-401	RF265-402	RF265-403

INSTRUMENT FOR REMOVAL OF I.U.D.



reference	description	size
742-160501	Kierukanpoistopihti	20 cm (työskentelypituus) Ø 3.0 mm



OY VESTEK AB

Martinkuja 4, 02270 ESPOO
Puh. (09) 8870 120, fax (09) 8870 1291



Rue Chainisse, 39
B-5030 Gembloux
Belgium
medsys@skynet.be

Tel. : + 32 81 56 84 84
Fax : + 32 81 56 88 84
E-mail :

www.medsys.be

SAUNDERS INSTRUMENT FOR REMOVAL OF I.U.D.



reference	description	size	shape
160-502	SAUNDERS INSTRUMENT FOR REMOVAL OF I.U.D.	31 cm / 3 mm	upwar



OY VESTEK AB
Martinkuja 4, 02270 ESPOO
Puh. (09) 8870 120, fax (09) 8870 1291

BIOPSY FORCEPS WITH ROTATING SHAFT



reference	description	size
160-186B	Tischler Roto pyöriii 360 ° ylöspäinkaareutuva kärki (Kokonainen, sis. kärjen ja kädensijan)	Työskentelypituus 21 cm Kokonaispituus 34cm
160-182B	Tischler Roto pyöriii 360 ° ylöspäinkaareutuva kärki HUOM! Vain kärkiosa	
160-180	Kädensija	



OY VESTEK AB

Martinkuja 4, 02270 ESPOO
Puh. (09) 8870 120, fax (09) 8870 1291

COMFORT-FLEX® DILATOR SET

For smooth and gentle dilation of the cervix...made of a malleable teflon material for frictionless natural lubrication, the Comfort-Flex® Dilator Set is excellent for use in intracervical dilation, uterine sounding, or intrauterine procedures. The gradual dilation combined with the flexible tip, ensure comfortable introduction.

Set contains:

- Os locator (1 ring) - naturally seeks and gently opens the external OS
- Canal dilator (2 rings) - gently traces the natural path of the cervical canal while steadily dilating
- Fundus sound (3 rings) - opens the internal OS and sounds the fundus to determine uterine depth



reference

Description

size

391-870

COMFORT-FLEX® SET

OY VESTEK AB

Martinkuja 4, 02270 ESPOO
Puh. (09) 8870 120, fax (09) 8870 1291

WILSON VASEKTOMIASETTI



reference	description	size	shape
470-010	WILSON VASEKTOMIASETTI sisältää:		
	470-011	14,5 cm	
	470-012	12,5 cm	